

**AGA 4531 INTRODUCTION TO AQUACULTURE**

# 4. Site selection and facility construction

- Siting requirements
- Preferable characteristics
- Fishpond design and construction

# Site selection

Improper site selection may lead to:

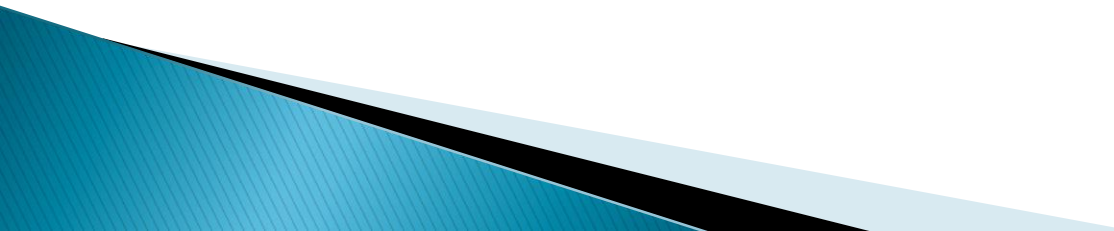
- ▶ high seepage,
  - ▶ dike erosion,
  - ▶ low productivity of the pond, resulting low yields and economic loss
  - ▶ inability to drain water completely, and
  - ▶ difficulties in harvesting
- 

# Criteria for selecting sites for fishponds

Factors for suitability of a site for establishing fishponds include:

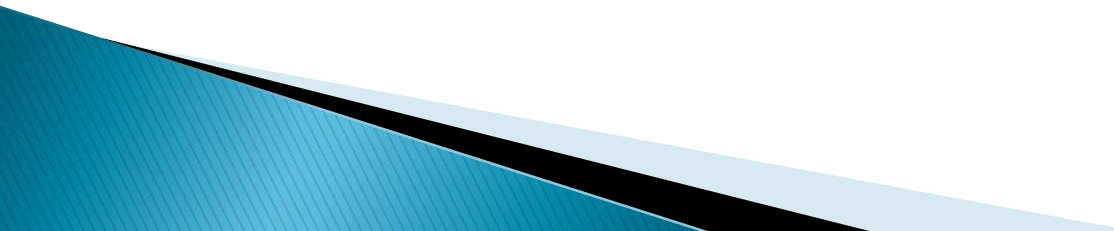
- ▶ land and its location
  - ▶ Water
  - ▶ Topography
  - ▶ soil type and presence or absence of obstacles
  - ▶ Other factors include security of the place, social economical and legal considerations.
- 

# Factors to be considered in site selection

## ▶ **1. Land requirements**

### a) Land size

- ▶ The size of the land must be large enough to allow construction of ponds.
- ▶ **What is the minimum commercial fishpond size?**
- ▶ Small ponds can only provide fish for household food and nothing more for sale.
- ▶ A pond size starting from 20m x 30m (600m<sup>2</sup>) can produce 300 kg of Tilapia a year, which can be sold at ZMW 18,000. This amount of money can be significant in the rural areas. Therefore, the pond size of 20m x 30m can be regarded as the minimum small-scale commercial size.
- ▶ **Larger ponds from 20m x 50m to more than 2 hectares are recommended for commercial fish production.** The larger the pond the more commercial it becomes.

### b) Land ownership/Social issues.

- ▶ As much as possible, the land must be fully owned by the intending farmer.

## 2. Location, Wetlands and Legal considerations

**a)** There are two main reasons why ponds should not be established in wetlands.

- ▶ i. Wetlands serve very important roles in conserving water for the community and therefore must always be preserved and protected.
- ▶ ii. In most cases wetlands have water with a lot of acid, which makes it difficult to grow fish in.

### **b) The suitable location of land for ponds**

- ▶ The most suitable location of land for ponds is land on a slope next to a flowing stream or river where a portion of the water is diverted into the pond without disrupting the other uses of the same water down stream

### ▶ 3. Topography and obstacles

- ▶ Slope: Landscape for constructing fish ponds must have a good slope



A bad slope

Constructing a pond on a steep slope involves the expense to remove a lot of earth to level the ground. It requires a lot of labour to remove a lot of soil, the lower dyke is not firm and it allows only small ponds.



A Gentle slope

The ease of constructing a pond on a gentle slope. Less soil is removed, the dykes are stable and it allows large ponds.

## ➤ Valleys

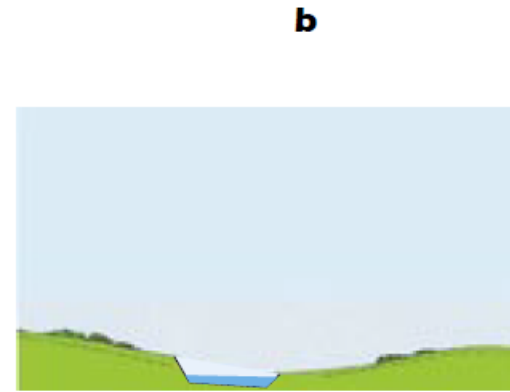

Constructing ponds in a very sharp V-valley involves extra costs of widening the valley. A lot of soil must be removed.

## ➤ Obstacles

Among obstacles usually found in pond sites are rocks/stones and trees or tree stumps.



To avoid the problem of hidden rocks, it is necessary to bore holes down to 1.5m at various points of the site during inspection of the site.

Then the area free from hidden obstacles is mapped out for pond construction.

## 4. Soil properties

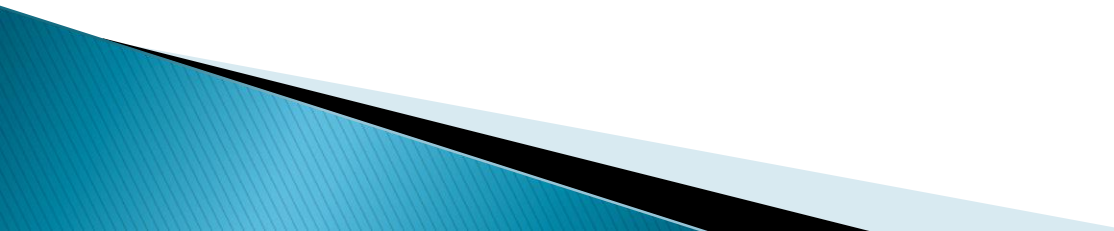
- ▶ Land should be comprised of good quality soil, with little or no gravel or rocks either on the surface or mixed in.
  - ▶ Farmers may consider importing clay soil for compacting in the fish bottom, sides and core trench to minimize seepage, though this may increase the cost of pond construction.
- 

## ▶ Will the soil hold water?

1. Dig a hole as deep as your waist

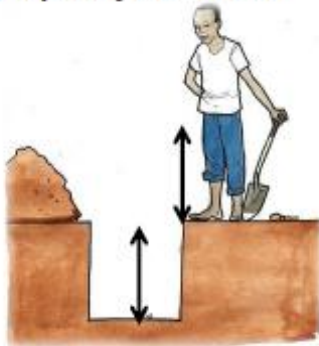

2. Early next morning fill the hole with water to the top



3. In the evening some water will have trickled away



4. Fill the hole again

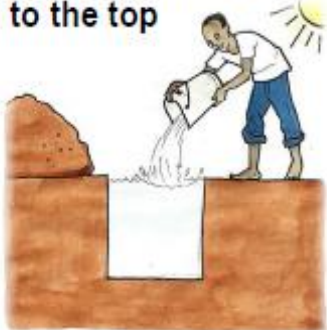

5. Cover the hole



6. Check next morning: Does the soil hold the water?



## ▶ Will the soil be stable when wet?

### Stability test

1. Take some soil and moisten it



2. Squeeze the soil by closing the fingers firmly



3. Open your hand again



If the soil holds the shape, it will be stable when wet.



If the soil falls apart, it won't be stable.

### Clay or silt?

1. Rub some soil between your hands



2. After rubbing: Is there some soil in the folds of your hand?



No:  
The soil consists of clay.



Yes:  
The soil consists of silt.

▶ Does the soil have adequate clay?

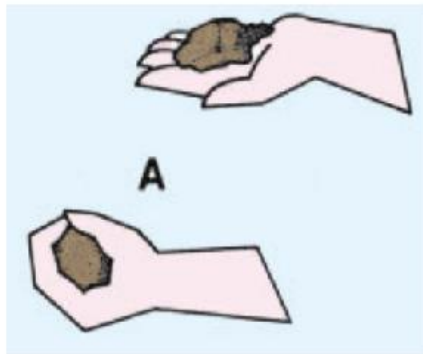

Take a handful of moist soil and squeeze it into a ball

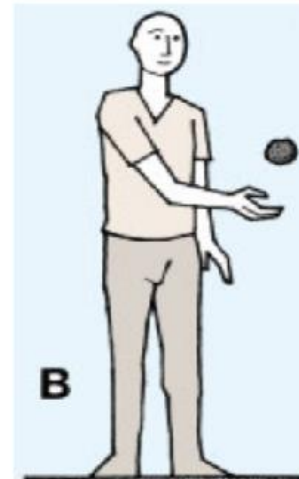

If the soil fall apart, its poor with too much sand



If the ball sticks together, is probably good soil with enough clay in it

## ▶ **5. Water supply and water quality**

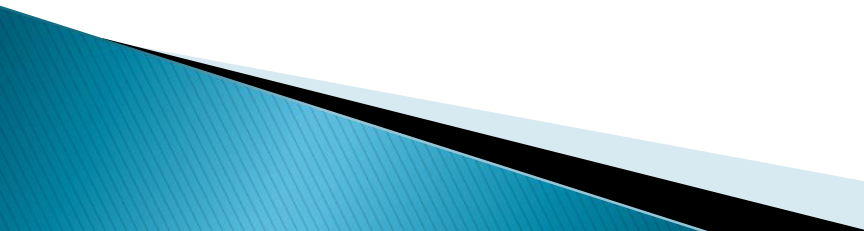
- ▶ **Water sources:** The most common sources of water used for aquaculture are surface waters (streams, springs, lakes), groundwater (wells, aquifers) and municipal water
  - ▶ **Quality:** should be investigated by taking a number of water samples from the proposed water source for laboratory analyses of physical, chemical, biological and micro-biological properties, including health hazards.
  - ▶ **Quantity:** Generally pumping capacity for fish ponds depend primarily on the volume of the pond and the flow of water per second.
  - ▶ For excavated ponds analysis of water requirements and water availability is relatively simple because they are usually constructed to exclude rainwater runoff, and water supply is controlled.
- 

# Other considerations

## 6. Legal empowerment and licensing

- ▶ licensing of farm establishments based on data on impact assessment and monitoring is considered to be the most practical way of enforcing orderly development.
- ▶ Not all development will require detailed environmental assessment and only major projects that are likely to have serious impacts need detailed assessment.
- ▶ Environmental impact Assessment (EIA) vs Environmental project brief (EPB)

## 7. Socio-economic considerations

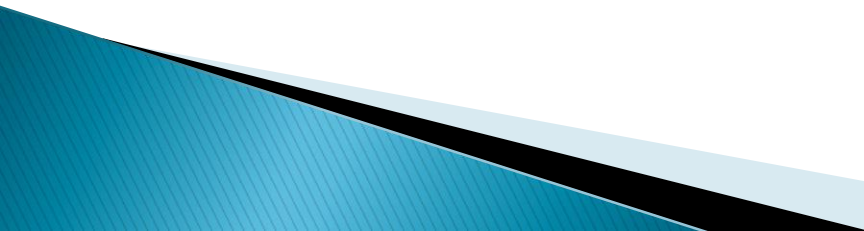
- ▶ **Flood hazard**
  - ▶ **Wind direction:** Wind plays a role in fish pond design. Strong wind generates wave actions that damage the sides of the dyke
  - ▶ **Type of vegetation:** The type of vegetation, its density, and the size and root system
  - ▶ **Availability of technical assistance**
  - ▶ **Sources of fingerlings**
  - ▶ **Competing use of land and water sources**
  - ▶ **Supplies and equipment**
  - ▶ **Marketing opportunities**
- 

# POND DESIGN AND CONSTRUCTION

## The qualities of a good fishpond

- ▶ easily accessible to allow supplies to reach the pond and fish to be taken to market
- ▶ Ponds should be drainable and should fill and drain by gravity without the need to pump out water
- ▶ The slope of the pond bottom should be drop by 1 to 2cm for each length of 10m to allow proper drainage without the need for pumping out the water
- ▶ The minimum water depth of a pond must be not less than  $\frac{1}{2}$  m while the maximum water depth must be not less than 1m (for small ponds up to 50m length) but not more than 1.7m for large ponds more than 100m long
- ▶ Water should not seep into the pond from the bottom of the pond. Such a pond will be difficult to drain.
- ▶ The type of soil surrounding the pond should hold water and be firm to prevent loss through seepage across pond sides or bottom

# Pond features

- ▶ **Layout of ponds:** It is very important to consider the layout of the ponds in relation to the topography of land, the source of water, and drainage and future expansion
- ▶ **Pond shape:** rectangular ponds are easier to construct and easy to fish by seining.
- ▶ **Pond size:** the larger the pond the more fish it can produce. Commercial ponds range from 20m x 50m to 200m x 500m. Larger ponds are less costly to construct per unit area but require larger equipment to operate and problems of harvesting are far greater than smaller ponds.

## Dyke - height

- ▶ Dyke height will be set by the depths that you have chosen for the shallow and deep ends of the pond.
- ▶ However, dykes must be built higher than the full water level to guard against overflowing. The additional height of the dyke above the full water level is called “freeboard.”
- ▶ Freeboards for ponds less than 1000 m<sup>2</sup> should range between 20 and 30 cm, but for larger ponds they can be up to 50 cm.

## Dyke Width

- ▶ The width of the dyke at its top should be equal its height but never less than a meter wide.
- ▶ The width should be great enough to allow transport of materials, fish, and farm equipment.

## Dyke slopes

- ▶ The slope of the pond dyke is the gradient of the dyke from the edge of the top width to the inside toe at the bottom of the pond.

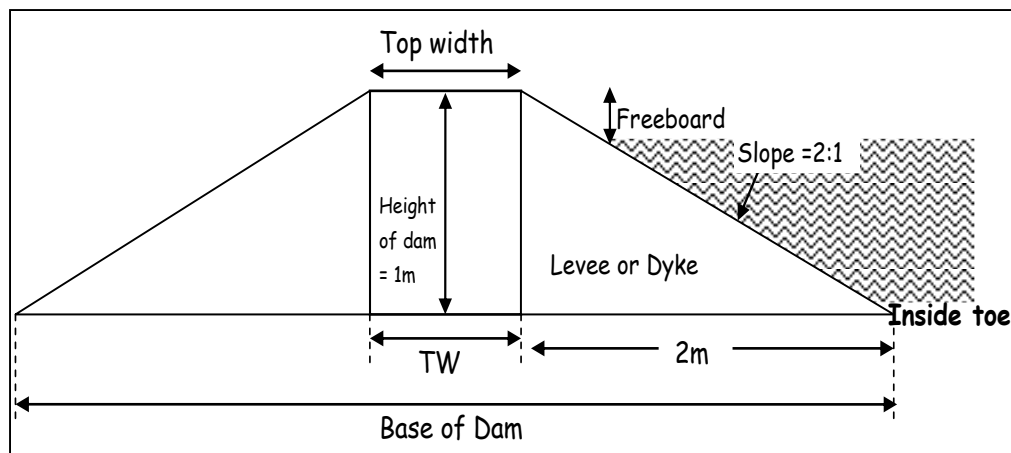

- ▶ It is recommended that pond dykes have a gentle slope of about 2:1. This, however, depends on the size of the pond. Larger ponds need to have a gentler slope

Size of Pond	Recommended Slope
5 – 20 ha	4:1 to 7:1
1500 m <sup>2</sup> to 5,000 m <sup>2</sup>	2:1 to 4:1
+ 150 m <sup>2</sup> to 1,500 m <sup>2</sup>	2:1
≤ 150 m <sup>2</sup>	1.5:1 to 1:1

## Pond bottom

- ▶ For the water to drain out, the pond bottom slopes gently towards the outlet end of the pond. A minimum bottom slope of 0.1–0.2% is recommended.
- ▶ The pond bottom should be smooth and free from bumps and hollows, to make it easier to haul the seine nets and to catch as many fish as possible. If the slope is too steep, it may be too shallow at one end or too deep at the other end.

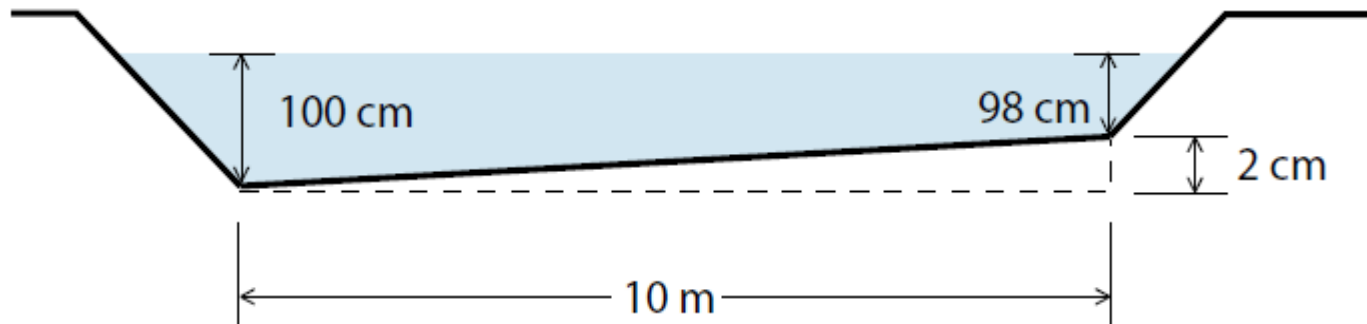

# Average Water Depth

- ▶ In ponds, sunlight can generally penetrate to a depth of about 30-80 cm depending on the levels of water turbidity.
- ▶ For this reason, a maximum water depth of 1.2 m is recommended. Beyond this depth, pond waters start becoming devoid of oxygen and stay cooler.
- ▶ The deeper the pond is, the more expensive it is to construct and the riskier it becomes to manage water quality because oxygen stratification becomes more likely

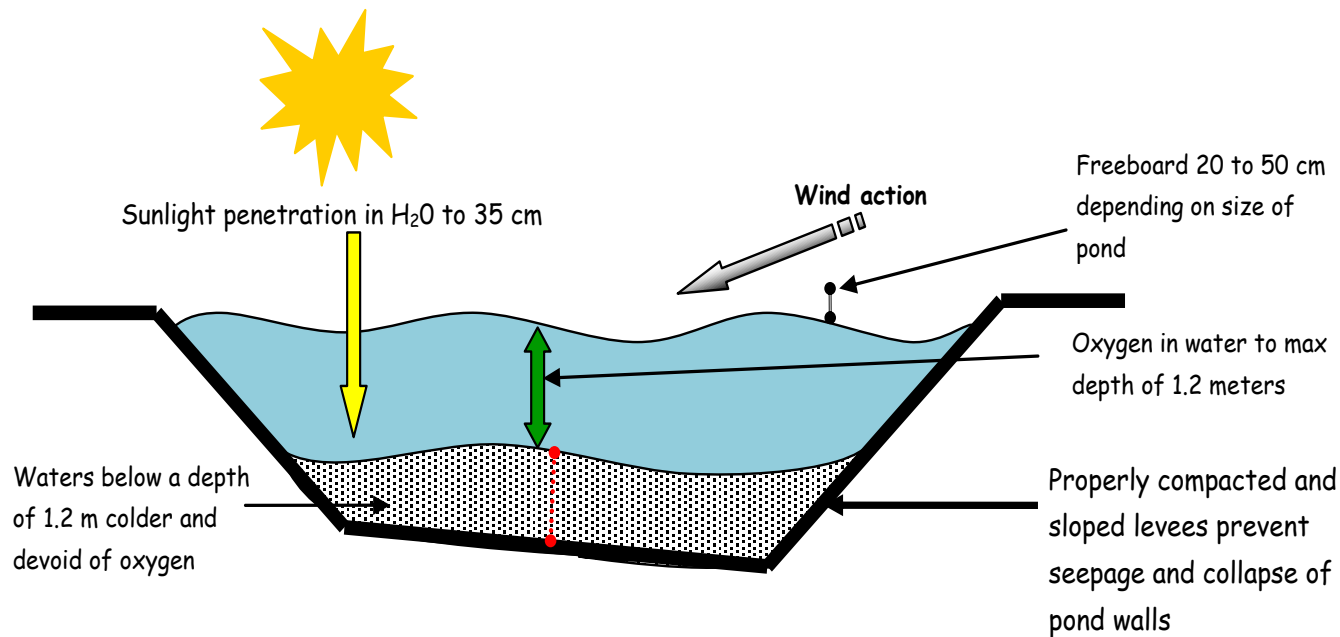

## Position of inlets and outlet pipes

- ▶ It is better to position inlet and outlet diagonally (Fig 3.9).
- ▶ If a pipe is used as an inlet, it should be projected enough into the pond so that water will fall into the pond at  $90^{\circ}$  directly into the pond and prevent dike erosion by falling along the dike.

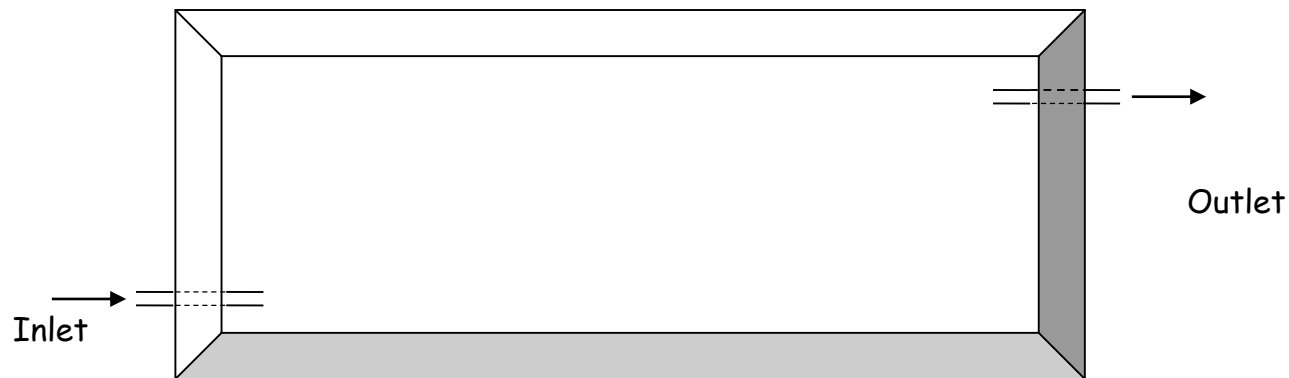

## Pond drainage systems

Pond drains are normally located at the deep end of the pond with the bottom sloping toward them.

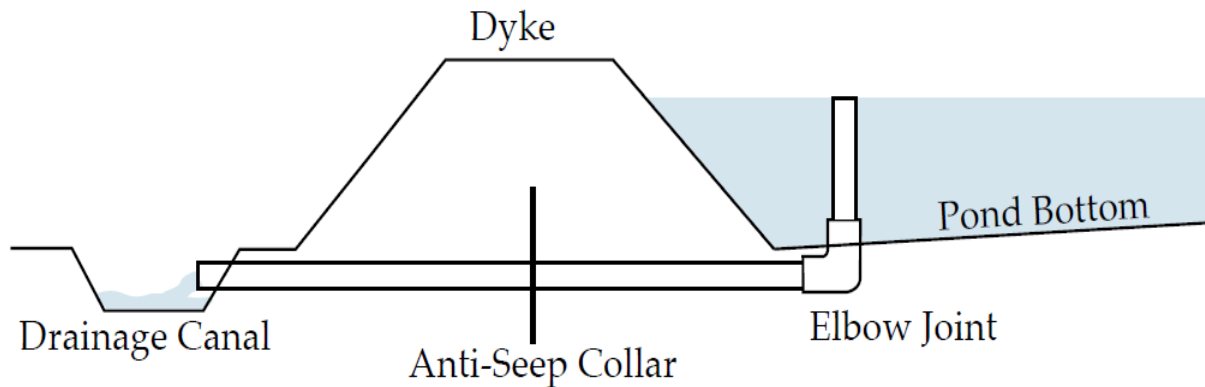

The diagram below gives the relationships between various pond dimensions.

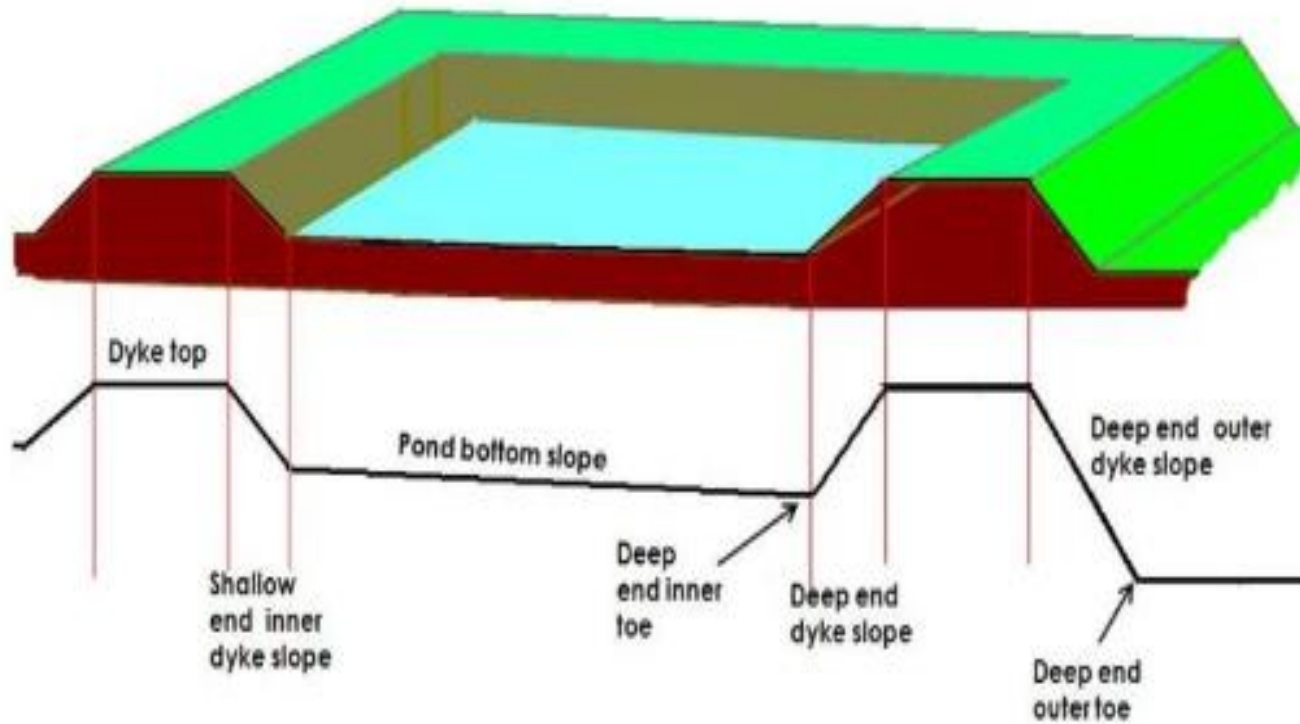

# Calculation of pond dimensions

Based on the above, the following apply:

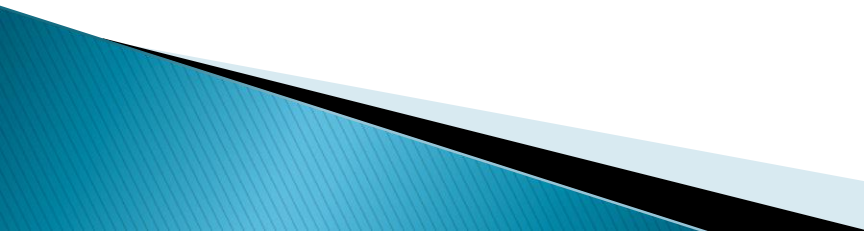
- ▶  $a$  = Water depth at deep end
  - ▶  $b$  = total pond depth at the deep end
  - ▶  $c$  = Free board
  - ▶  $d$  = Water surface length
  - ▶  $e$  = Water surface width
  - ▶  $X$  = The difference between the water depth at the deep end and the shallow end
- 

# Calculation of pond dimensions

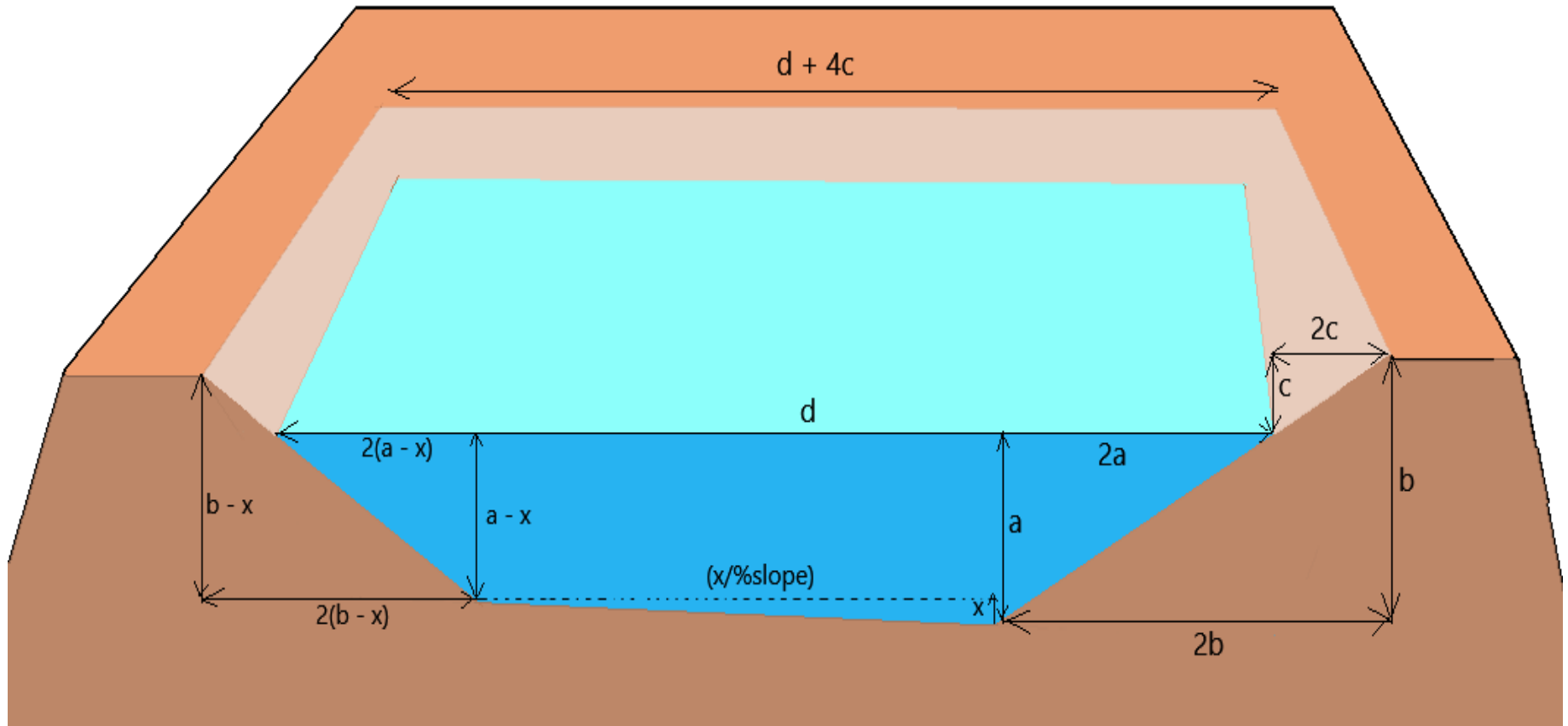

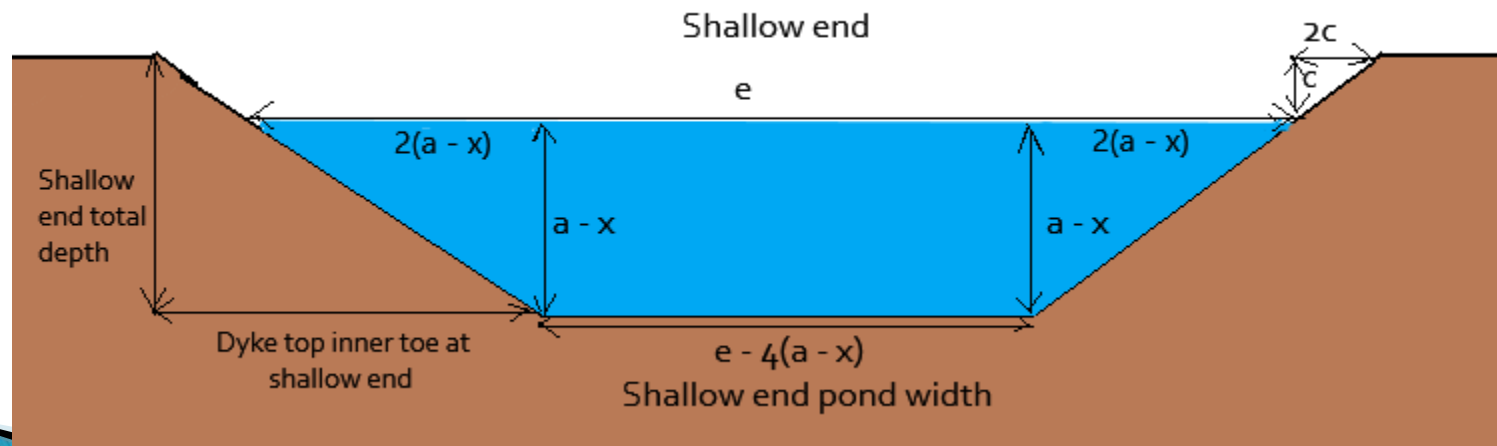
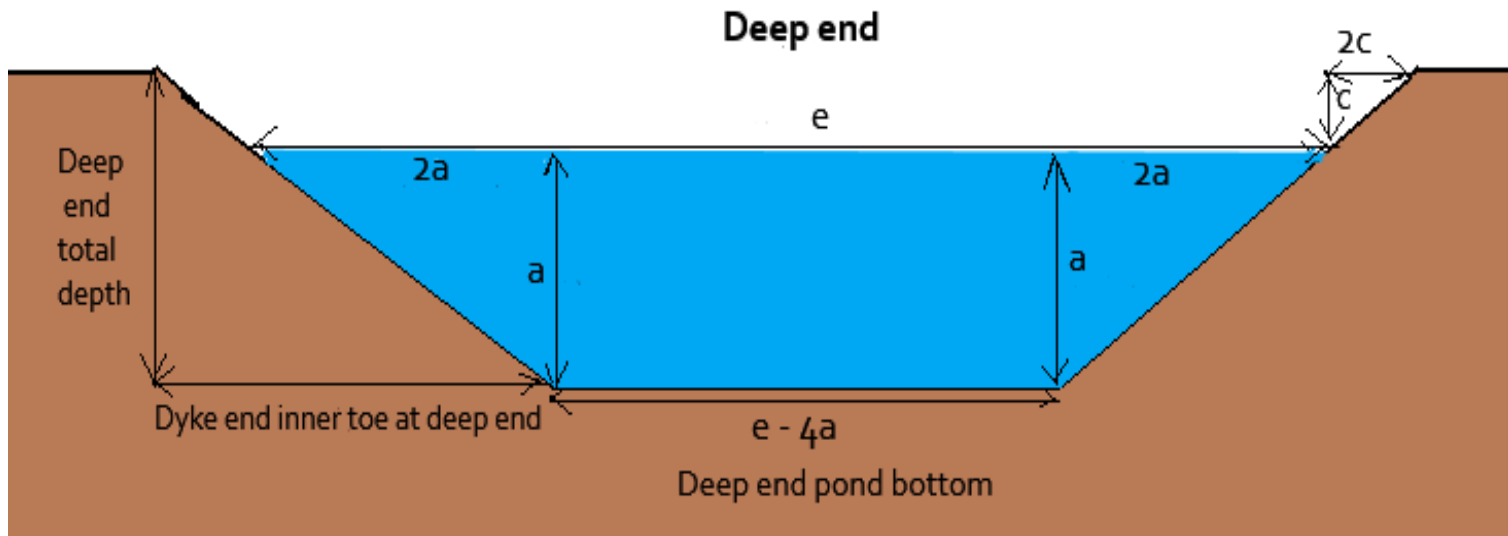

## Example

- ▶ The diagram below gives the relationships between various pond dimensions for a  $300\text{m}^2$  pond based on the assumptions that:
- ▶ Length of water surface is 30m
- ▶ Width of water surface is 10m
- ▶ Water Depth at deep end 1.2m
- ▶ Dyke slope 1: 1
- ▶ Bottom slope 1%
- ▶ Free Board 30 cm

Lengthwise section of a typical 1:1 fish pond showing relationships between various measurements

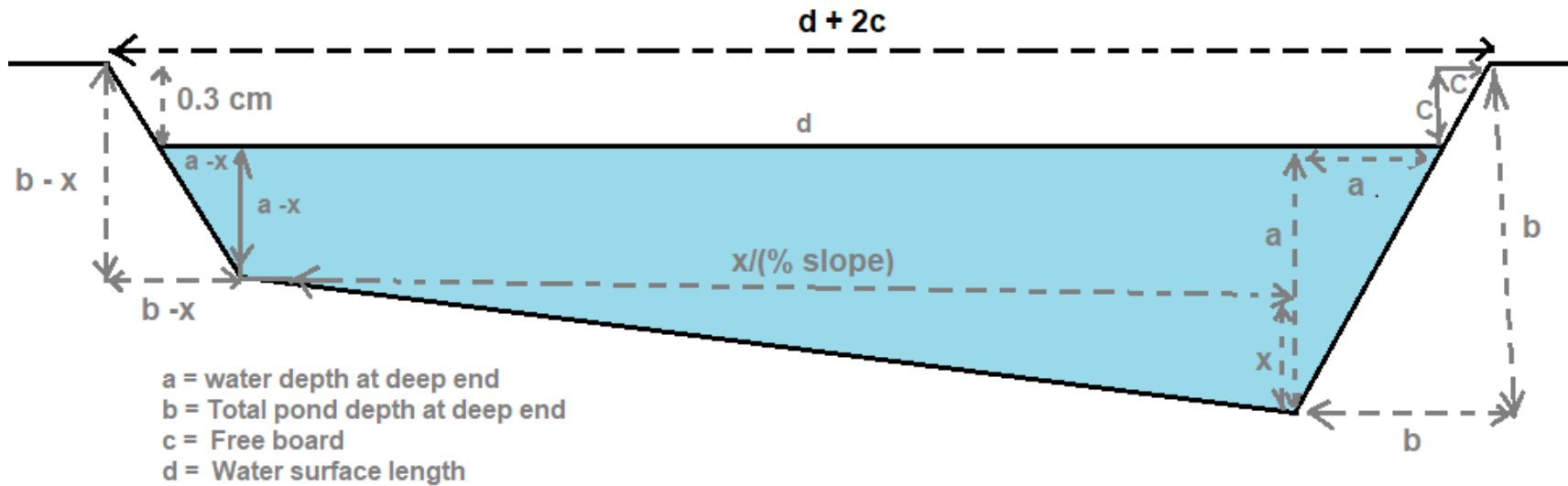

# Lengthwise section

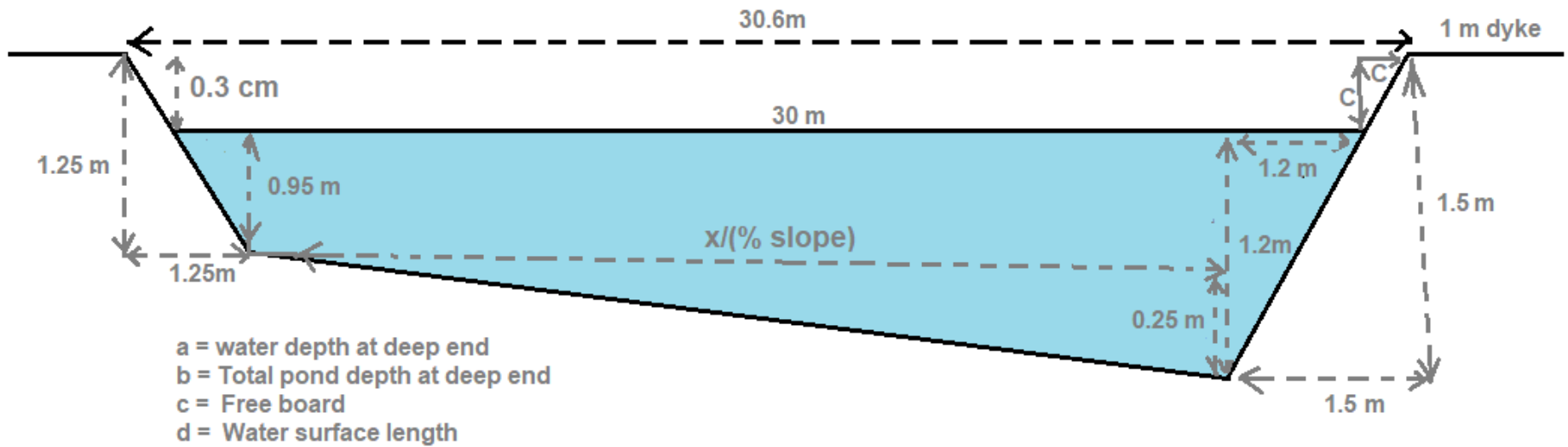

# Deep end

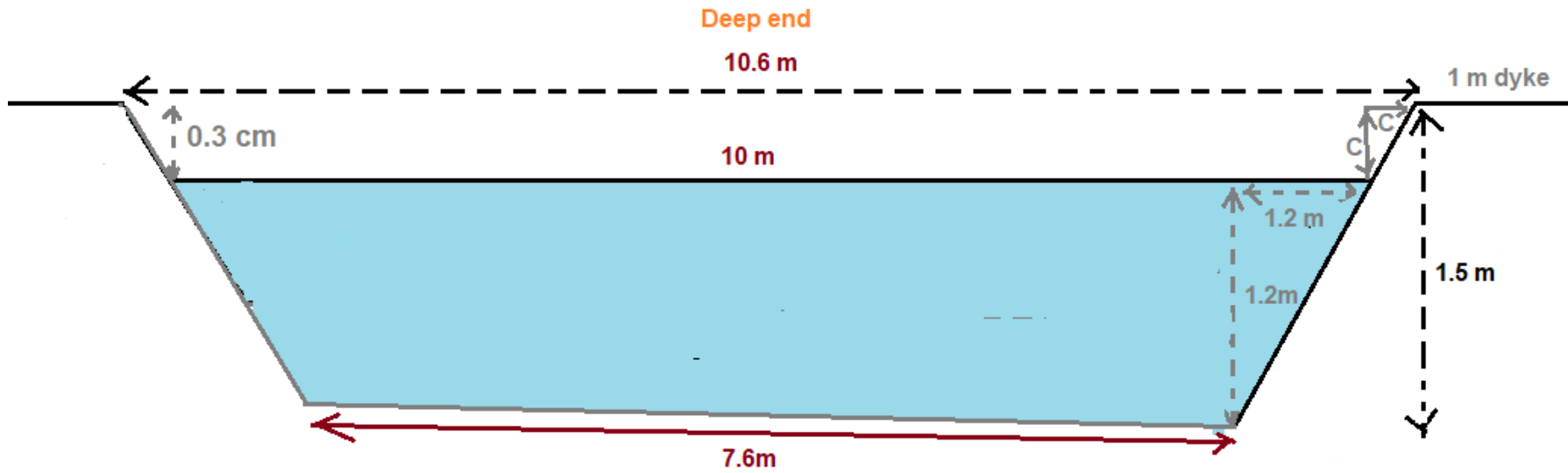

- a = water depth at deep end
- b = Total pond depth at deep end
- c = Free board
- d = Water surface length

# Shallow end

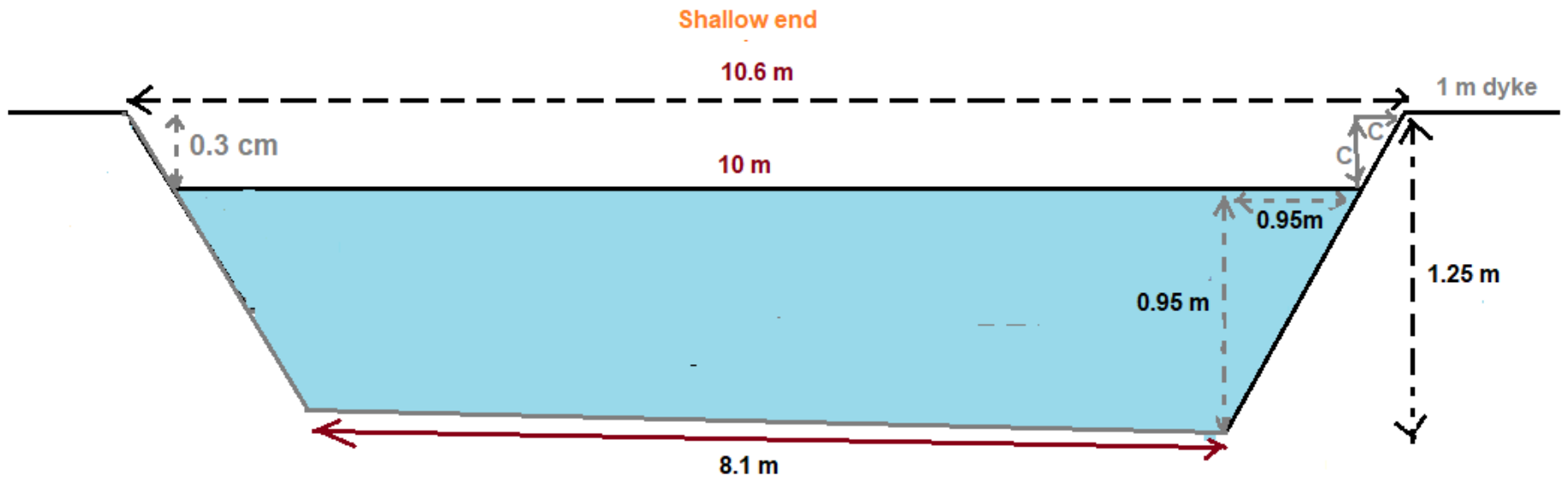

- a = water depth at deep end
- b = Total pond depth at deep end
- c = Free board
- d = Water surface length

## Plan view showing pegging positions

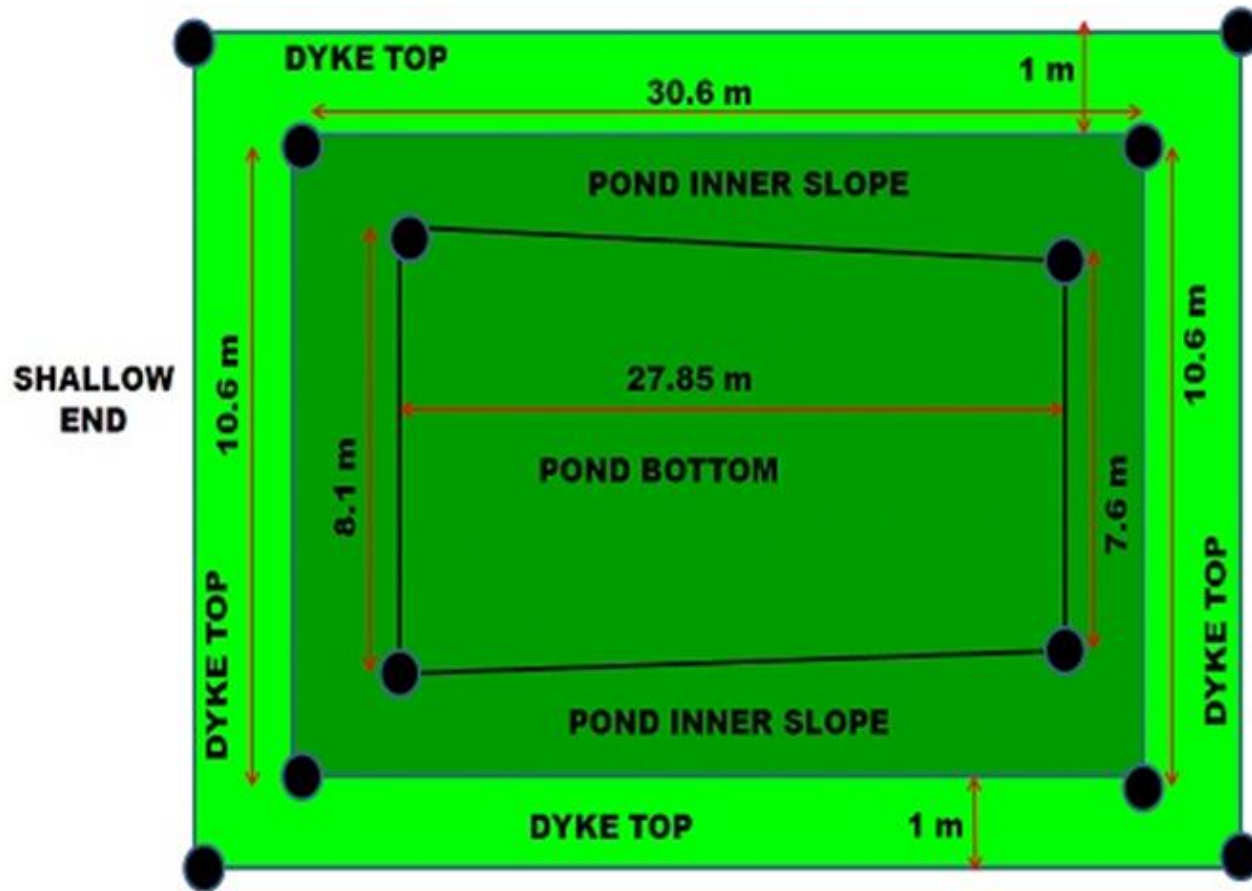

Plan view showing the pegging positions for a 300 m<sup>2</sup> pond measuring 30 by 10 metres at the water surface and inner dyke slope of 1:1.

# Important formulas

- ▶ Total pond length =  $d+4c$
- Total pond width =  $e+4c$
- Shallow end water depth =  $a-x$
- Shallow end total depth =  $b-x$
- Shallow end bottom width =  $e-4a-4x$
- Deep end bottom width =  $e-4a$
- Dyke top-Inner toe horizontal distance at deep end =  $2b$
- Dyke top-Inner toe horizontal distance at shallow end =  $2b-2x$

## Calculations for ponds with dyke slope 1:1, 1:2 and 1:3

POND MEASUREMENTS	Pond 1	Pond 2	Pond 3
DYKE SLOPE	1:1	1:2	1:3
Total pond length	$d+2c$	$d+4c$	$d+6c$
Total pond width	$e+2c$	$e+4c$	$e+6c$
Shallow end water depth	$a-x$	$a-x$	$a-x$
Shallow end total depth	$b-x$	$b-x$	$b-x$
Shallow end bottom width	$e-2(a-x)$	$e-4(a-x)$	$e-6(a-x)$
Deep end bottom width	$e-2a$	$e-4a$	$e-6a$
Dyke top–Inner toe horizontal distance at deep end	$b$	$2b$	$3b$
Dyke top–Inner toe horizontal distance at shallow end	$b-x$	$2(b-x)$	$3(b-x)$

# Example 1

- ▶ Example for a pond with water surface of 600 m<sup>2</sup> (30 × 20 m), assuming water depth at deep end 1.2 m, water depth at shallow end 0.95m total pond depth at deep end 1.5m, free board 30 cm, dyke slope 2:1, dyke top width 1m and bottom slope (1%)

- ▶  $a =$  Water depth at shallow end  $= 1.2$  m
- ▶  $b =$  total pond depth at the deep end  $= 1.5$  m
- ▶  $c =$  Free board  $= 0.30$  m
- ▶  $d =$  Water surface length  $= 30$  m
- ▶  $e =$  Water surface width  $= 20$  m
- ▶  $X =$  the difference between the water depth at the deep end and the shallow  $= 0.25$  m

- ▶ Total pond length =  $d + 2c = 30 + 2(0.30) = 30.6\text{m}$
- ▶ Total pond width =  $e + 2c = 20 + 2(0.30) = 20.6\text{m}$
- ▶ Shallow end water depth =  $a - x = 1.2 - 0.25 = 0.95\text{m}$
- ▶ Shallow end total depth =  $b - x = 1.2 - 0.25 = 1.25\text{ m}$
- ▶ Shallow end bottom width =  $e - 2a - 2x = 20 - 2(1.2 - 0.25) = 18.1\text{ m}$
- ▶ Deep end bottom width =  $e - 2a = 20 - 2(1.2) = 17.6\text{m}$
- ▶ Dyke top–Inner toe horizontal distance at deep end =  $2b = 2(1.5) = 3$
- ▶ Dyke top–Inner toe horizontal distance at shallow end =  $2b - 2x = 2(1.5 - 0.25) = 2.5\text{m}$

Based on the above measurements a detailed pond drawing is derived as shown below

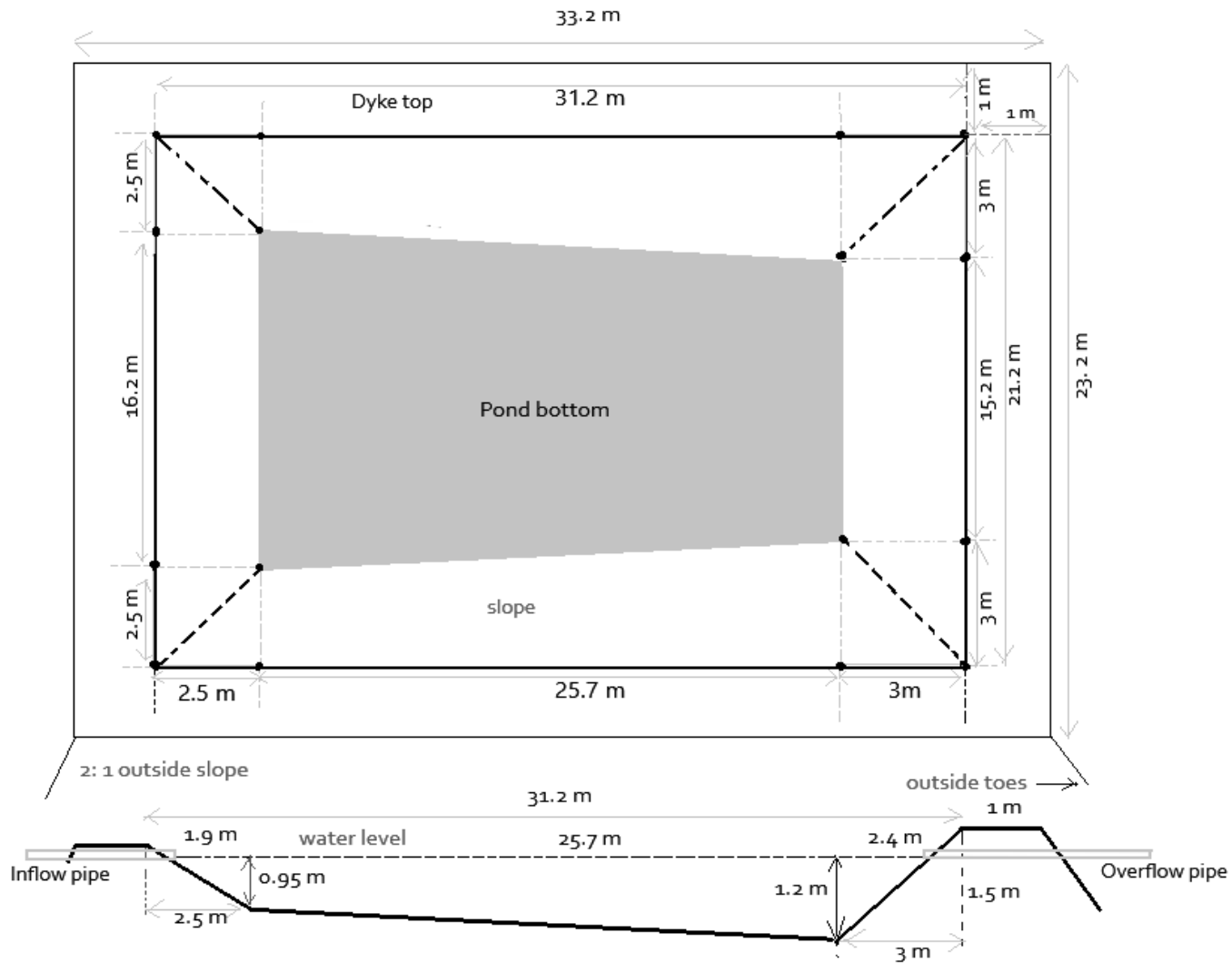



A well constructed pond dike

# Manual Construction of Fish Ponds

## Pegging the ponds

1. Peg the outer edges of the dyke crest

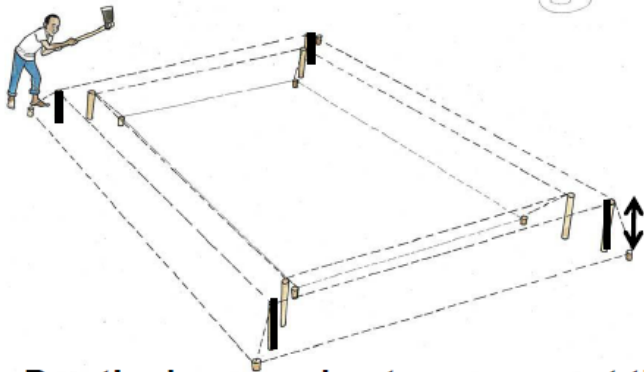

2. Peg the inner edges of the dyke crest

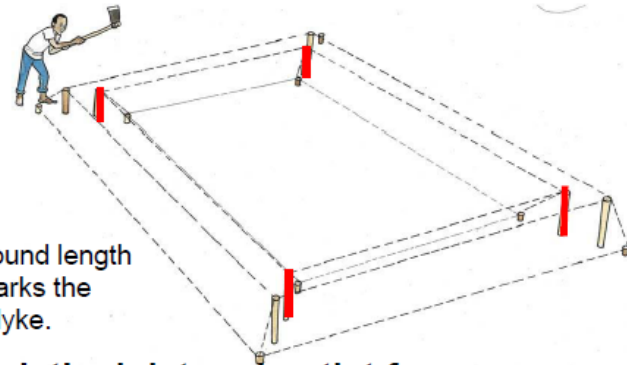

3. Peg the inner and outer corners at the bottom of the slope

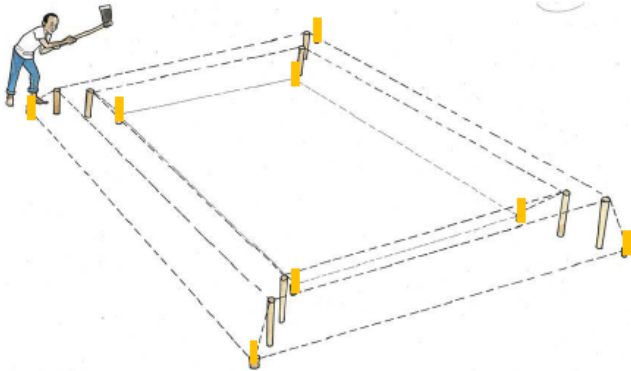

4. Mark the inlet and outlet furrow

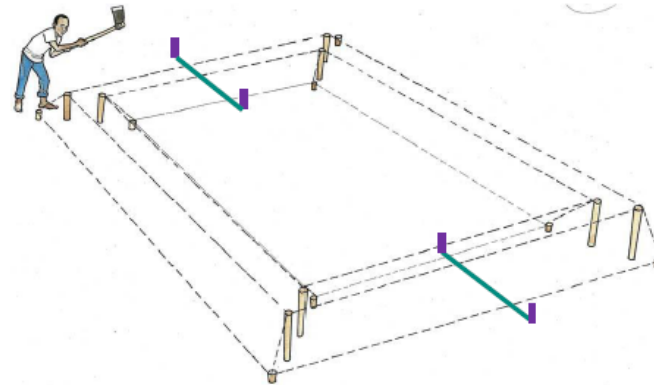

# Pond building in successive steps (1)

1. Clear the ground and remove the topsoil

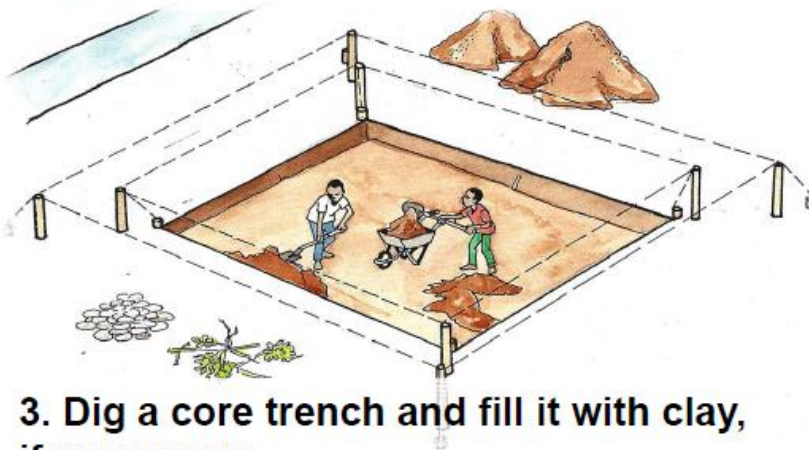

2. Dig the inlet ditch

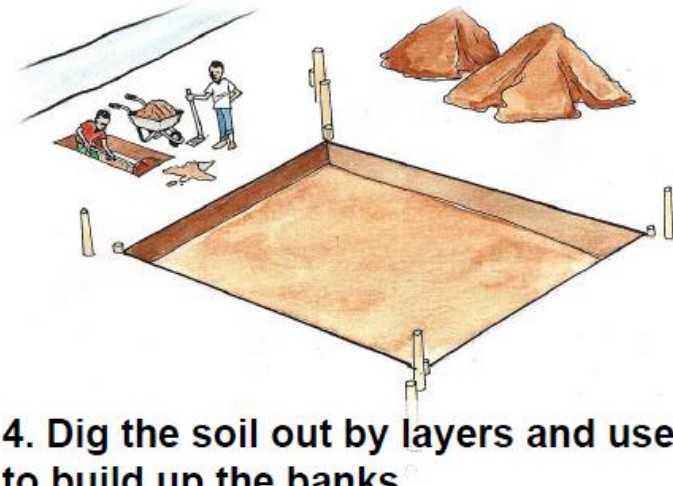

3. Dig a core trench and fill it with clay, if necessary

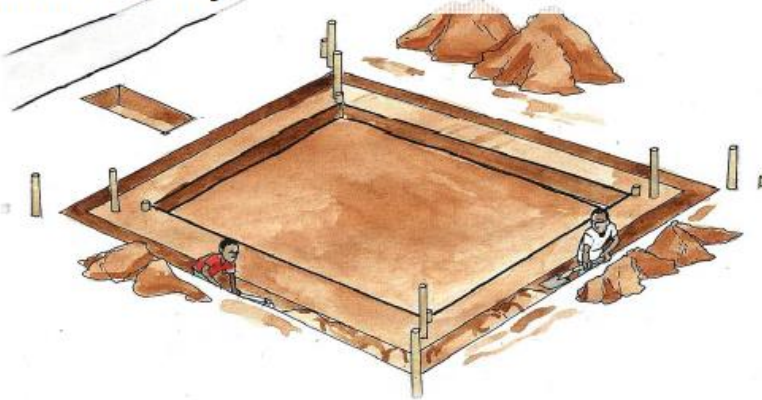

4. Dig the soil out by layers and use it to build up the banks

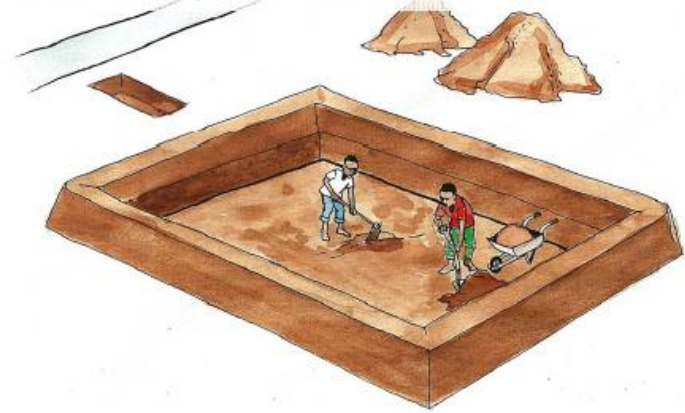

## Pond building in successive steps (2)

5. Form the inside and outside slopes of the banks



6. Cover the top and the outside slopes of the banks with topsoil

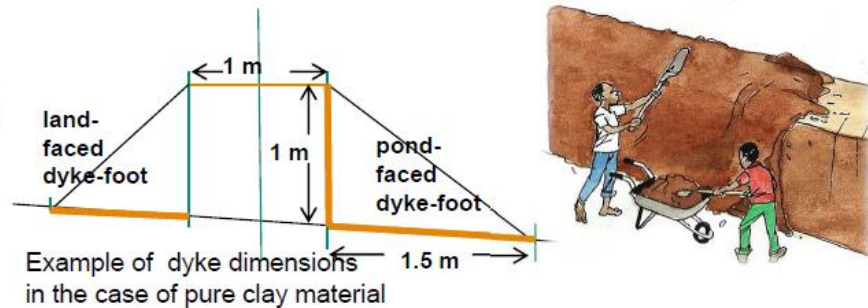

7. Dig a draining ditch inside the pond

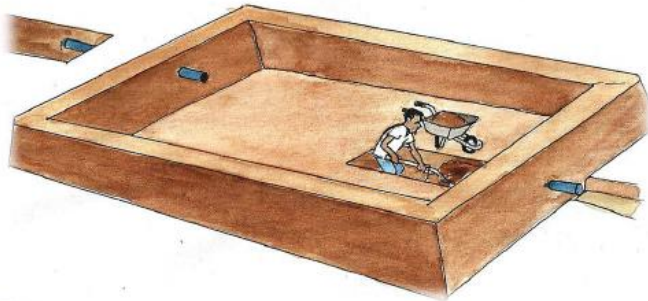

8. Stamp the bottom of the pond and the slopes of the banks

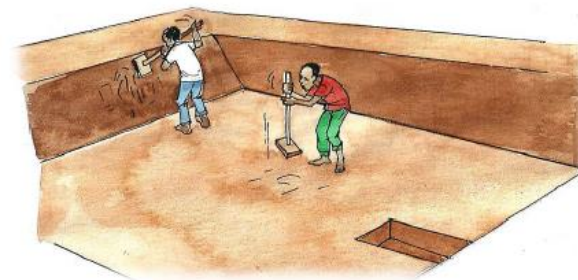

## How a completed pond should look like

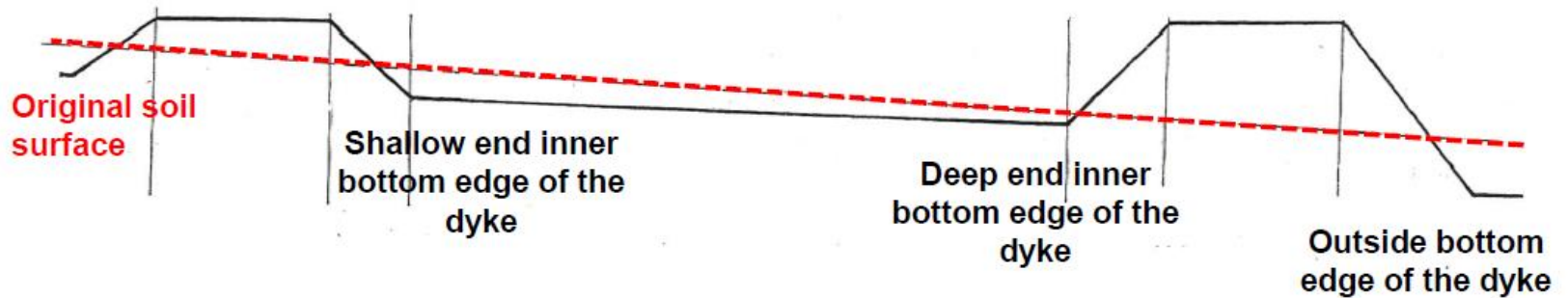
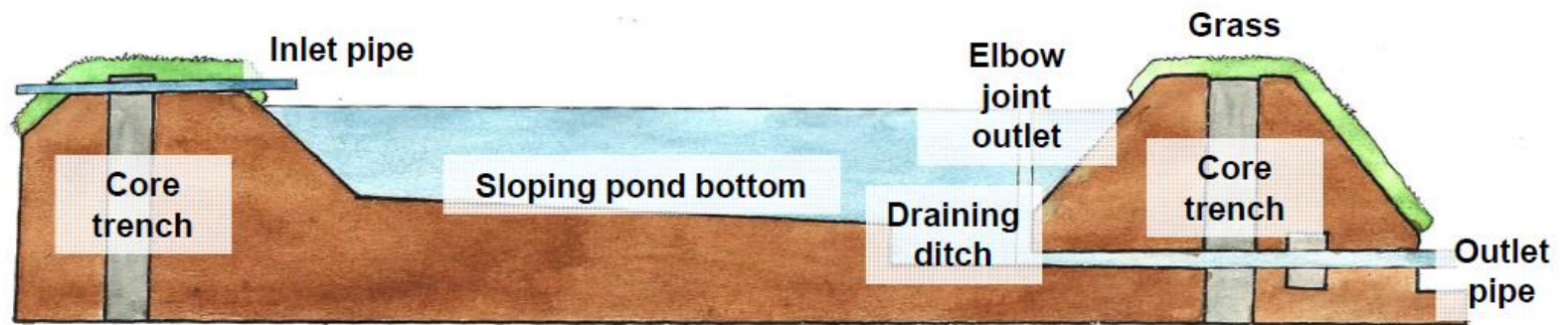



## Construction using machinery

- ▶ The selected site should be free from vegetation, bushes and other obstacles
- ▶ it should be levelled so that demarcation line of the pond area can be drawn.
- ▶ The design dimensions of proposed pond can be drawn with the help of rope and lines for demarcation can be done with lime powder
- ▶ Initially digging of pond must be started
- ▶ at the central portion of layout to a designed depth indicated by stakes.
- ▶ JCB Backhoe machines are commonly used



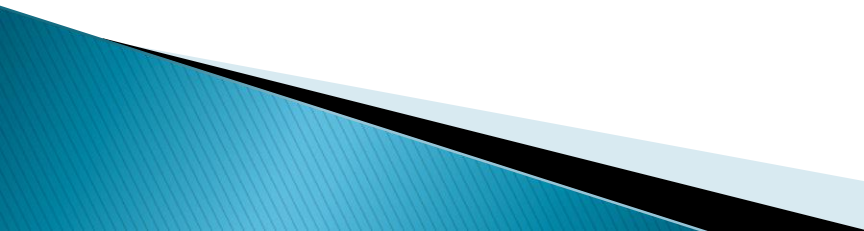

## Pond liner Installation

- ▶ A high-quality pond liner will help the pond retain its shape and prevent its water from leaking.
  - ▶ It acts as a barrier between the pond's water and the soil beneath the structure that would otherwise absorb the water.
  - ▶ the area where you dig your pond might expose the liner to sharp rocks that could puncture the material.
  - ▶ 500 microns PVC pond liner is commonly used in Zambia
- 

# Pond liner Dimensions

Total Liner Length = Pond Length + Depth 1 (D1) + Depth 2 (D2) + Overlap 1 (O1) + Overlap 2 (O2)

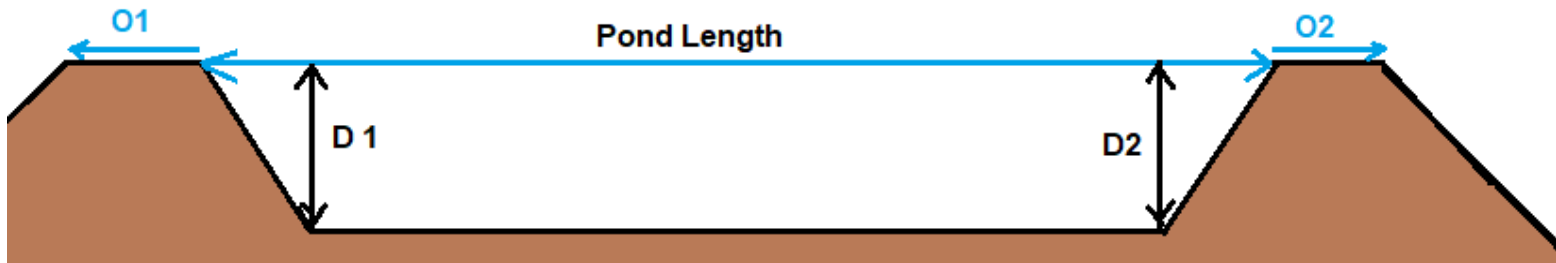
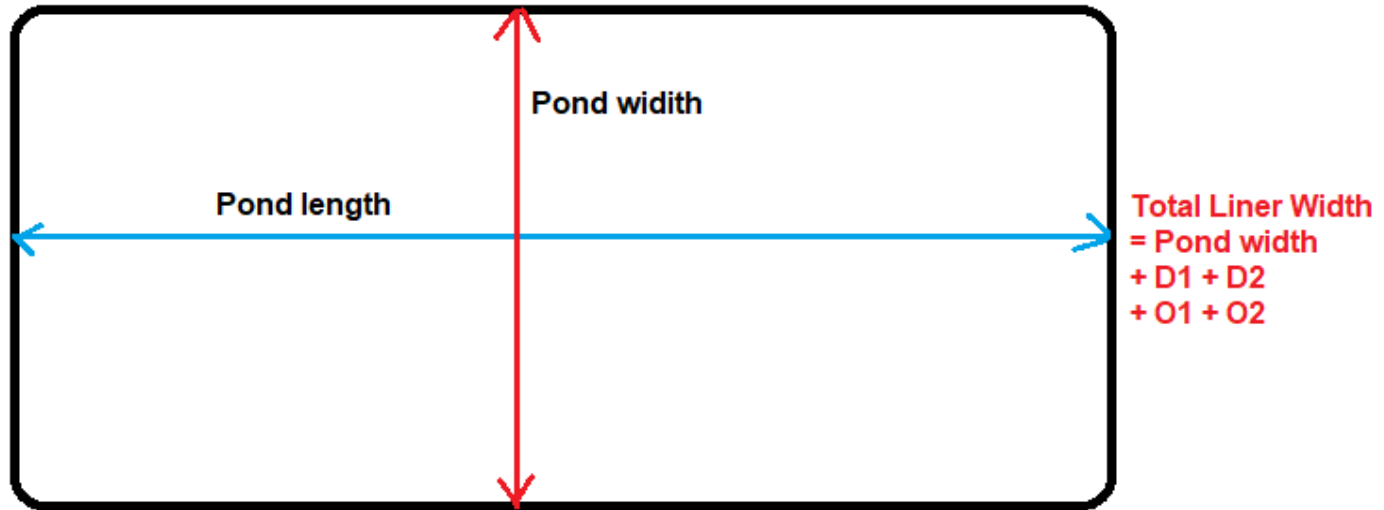

## Pond Liner joining

- ▶ Using plastic welder and heat gun









# END OF TOPIC

1. Quiz 2
2. Assignment 1
3. Test 1